

MATABI

evolution 10 - 15 LT

SEU PARCEIRO PARA
PULVERIZAÇÃO PRECISA

evolution 10 LT evolution 15 LT



PULVERIZA SEM ESFORÇO A HORTA E O JARDIM

**Lithium Ion
BATTERY**



10
Litros

2,5 gal (USA)



15
Litros

2,5 gal (USA)

evolution 10 LT

evolution 15 LT

Bateria de alto
rendimento

1 carga =

MAX.
15 x



100-150L
26-40 gal (US)

MAX.
10 x



100-150L
26-40 gal (US)

JARDIM E HORTA

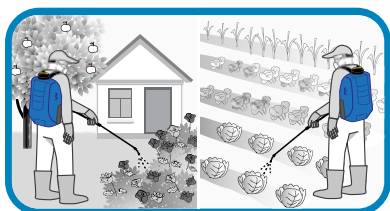

LEVE E ERGONÔMICO



BATERIA DE LÍTIU RECARREGÁVEL



Alça integrada
e ergonômica
para transporte

Mangueira reforçada

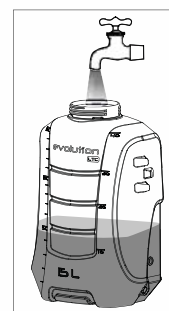

Ampla boca
do reservatório

Lança de fibra de
vidro 0,75 m. (2.46 ft)

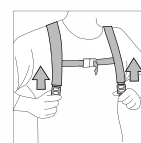

Correias
acolchoadas e
reguláveis, com
fechamento
na frente

Bico cônico regulável
Aplicações Inseticidas

EXTRA:
Bico leque de precisão
Aplicações herbicidas



SEU PARCEIRO PARA
PULVERIZAÇÃO PRECISA

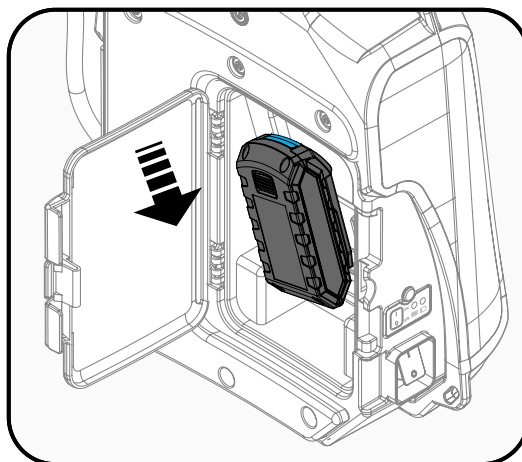

Bateria protegida de fácil
acesso e substituível

* Carregador incluso

evolution 10 LT

MAX.
15 x



100-150L
26-40 gal (US)

12V
BATERIA
Li-Ion

evolution 15 LT

MAX.
10 x



100-150L
26-40 gal (US)

BICOS INCLUSOS para diferentes tipos de tratamentos (Consulte para mais opções de bicos).

INSECTICIDA/FUNGICIDA

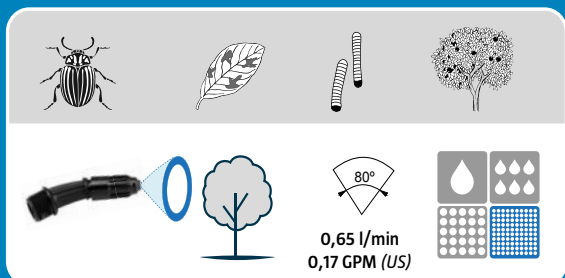

HERBICIDA

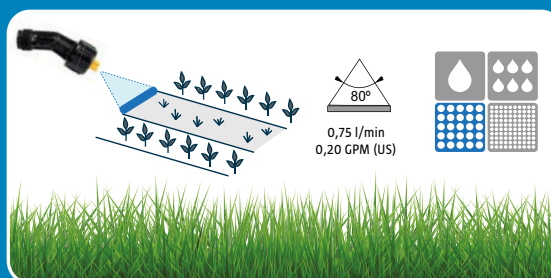

CARACTERÍSTICAS TÉCNICAS

PESO LÍQUIDO	CAPACIDADE NOMINAL	PRESSÃO MÁXIMA	BATERIA (íon de lítio)	TEMPO DE CARREGAMENTO MÁXIMO	AUTONOMIA LITROS POR CARREGAMENTO DE BATERIA	CÓDIGO
3.60 kg 8 lb	10 L 2.5 gal (US)	5,5 bar 80 PSI	12 V 2.6 Ah	4 h	100 L - 150 L 26-40 gal (US)	8.30.49 evolution 10 LT
3.90 kg 8.6 lb	15 L 4 gal (US)	5,5 bar 80 PSI	12 V 2.6 Ah	4 h	100 L - 150 L 26-40 gal (US)	8.30.25 evolution 15 LT

ACESSÓRIOS OPCIONAIS

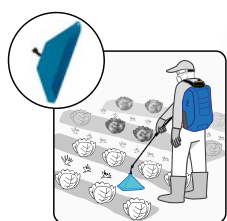

Chapéu de napoleão

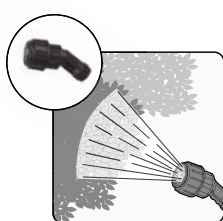

Bico com 4 orifícios

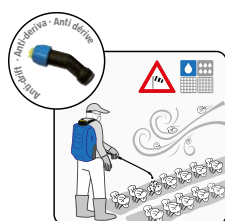

Bico espuma

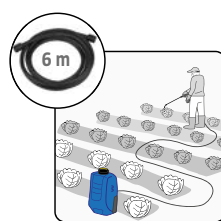

Mangueira

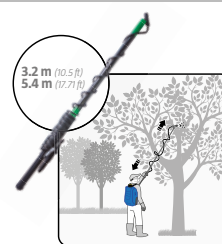

Lança telescópica

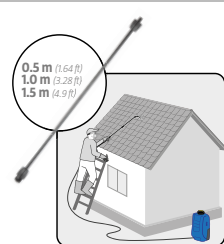

Extensões