

NEKATU GABE IHINZTATU ZURE LORATEGIA ETA BARATZEA



Bateria Li-Ion

Errendimendu
handiko
bateria
Karga 1 =

MAX.
15 x



100-150L
26-40 gal (US)

LORATEGIA ETA BARATZEA

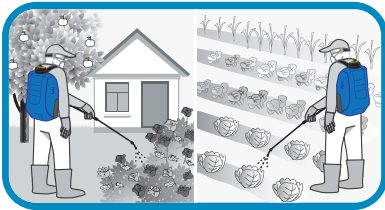

ARINA ETA ERGONOMIKOIA



**LITIOZKO BATERIA
BIRKARGAGARRIA**



10
litro
4 gal (USA)

Helduleku integratua
eta ergonomikoa



Mahuka indartua

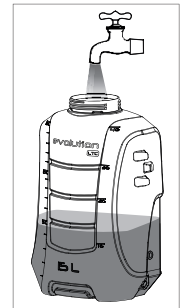

Betetzeko aho zabala

Beira-zuntzeko lantza
0,75 m (2,46ft)



Uhal barrubigunak eta
doigarriak, bularrean
itxigailuarekin

Pita koniko erregulagarria.
Intsektizidekin erabiltzeko

ESTRA:
Deriba txikiko pita haize-
emailea.

Herbizidekin erabiltzeko



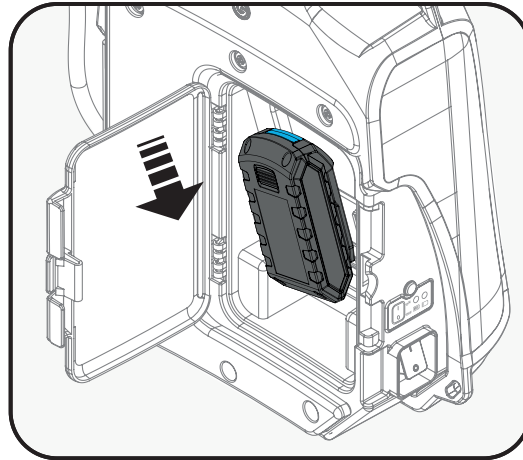

Babestutako bateria,
erraz iritsi eta aldatu
daitekeena

* Kargatzekoa barne

MAX.
15 x 
100L-150L
26-40 gal (US)

12V
BATERIA
Li-Ion

TRATAMENDU MOTA DESBERDINETARAKO PITAK DITU . (Beste pita mota batzuetarako, kontsultatu).

INTSEKTIZIDA/FUNGIZIDA

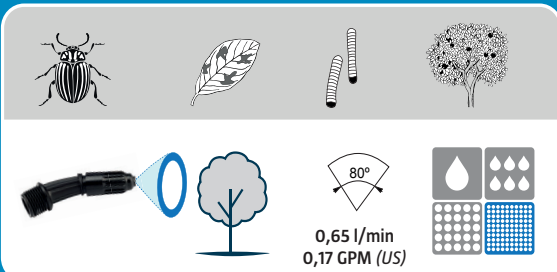

HERBIZIDA

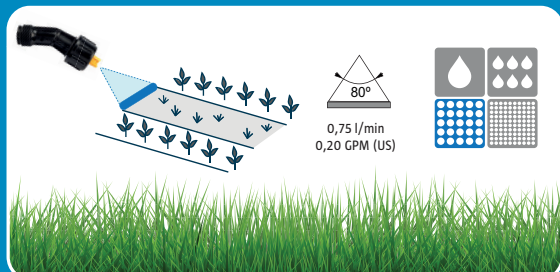

EZAUGARRI TEKNIKOAK

PISU GARBIA	GAITASUN NOMINALA	PRESIO GEHIENAKOAK	BATERIA (Li-Ion)	DENBORA KARGA GEHIENAKOAK	AUTONOMIA LITROAK BATERIA KARGA	KODEA
3.60 kg 8lbs	10 L 2.5 gal (US)	5,5 bar 80 PSI	12 V 2.6 Ah	4h	100 L-150 L 26-40 gal (US)	8.30.49

HAUTAZKO OSAGARRIAK

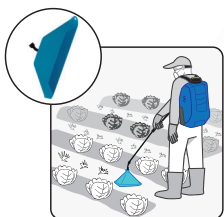

Kanpaia

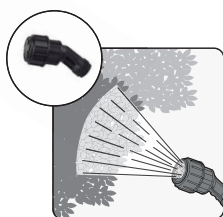

4 zuloko pita

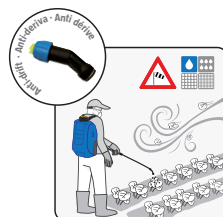

Aire-pita barne

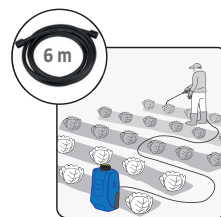

Mahuka

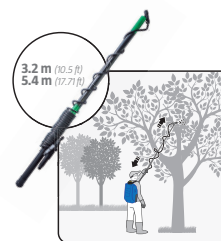

Lantza teleskopikoa

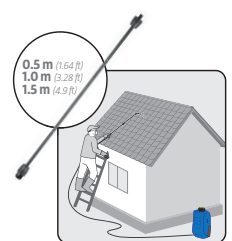

Luzagailua