



Electric battery sprayer (18 Li-Ion) with level indicator and 20 litre capacity. Lightweight and ergonomic, it is specifically designed for extensive agricultural crops.



Advantages

- Electric sprayer with high performance membrane pump and high flow nozzles for extensive agricultural crops.
- LTC Electronic control which ensures a homogeneous and effortless treatment.
- Instant start-up and stop of spraying.
- Two working positions: Insecticide/Fungicide and Herbicide
- It includes a set of nozzles to ensure fine droplet sizes and greater coverage in insecticide/fungicide treatments and to reduce drift and increase efficiency in herbicide treatments.
- High performance with: fiberglass lance, reinforced hose and INOX handle.
- Suitable for application of products of natural origin (pelargonio, acetic, etc...).



Technical information

Technical information	EVOLUTION 20 LTC-s
HOSE	Reinforced PVC
STANDARD NOZZLES	Adjustable cone nozzle, fan, mirror and four holes
LANCE	Fiberglass
USEFUL CAPACITY	20 L
TOTAL CAPACITY	21 L
NET WEIGHT	4.3 Kg
LANCE AND EXTENSIONS	0.75m lance
PRESSURE CONTROL	YES
AUTONOMY	From 100 L to 400 L
HANDLE	Stainless steel

Logistics data

Logistics data	EVOLUTION 20 LTC-s
CODE	8.30.42
EAN	84.14685.04021.3
CONDITIONING	1 unit
UNITS PER PALLET	14 units
DIMENSIONS PER PALLET	1200 X 800 X 1020

Functional information



Stainless steel handle



Reinforced hose



Integrated and ergonomic transport handle



Wide filler opening

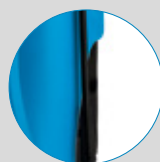

Fiberglass lance



High performance membrane pump



Adjustable padded straps with front fastener



Li-Ion battery (18V)



2 working positions



Set of nozzles



ACCESSORIES

Personalize your sprayer adapting it to your application needs (height, hard-to-reach areas...)



3.2 M TELESCOPIC LANCE
Reference 8.35.40.913
5.4 M TELESCOPIC LANCE
Reference 8.35.40.915



CONICAL HOOD
Reference 8.34.40.870
RECTANGULAR HOOD
Reference 8.34.40.871



6 M HOSE
Reference 8.30.45.805



ANTI-DRIFT NOZZLE (INDUCED AIR) 80°
Reference 8.34.46.814
ANTI-DRIFT NOZZLE (INDUCED AIR) 120°
Reference 8.34.46.804

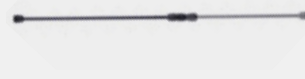

TELESCOPIC EXTENSION
Reference 8.35.40.876



QUADRUPLE BOOM
Reference 8.34.60.870



DOUBLE ADJUSTABLE NOZZLE
Reference 8.34.46.802

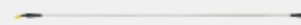

1 M ALUMINIUM LONG LANCE
Reference 8.34.60.871
1.5 M ALUMINIUM LONG LANCE
Reference 8.34.60.872

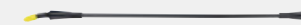

1 M FIBREGLASS LANCE TUBE WITH COMPLETE ELBOW
Reference 8.34.60.873
1.5 M FIBREGLASS LANCE TUBE WITH COMPLETE ELBOW
Reference 8.34.60.874



0.25M FLEXIBLE TUBE
Reference 8.34.60.937



LI-ION 18 V BATTERY
Reference 8.30.45.816

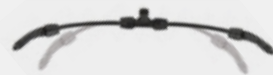

FLEXIBLE DOUBLE NOZZLE
Reference 8.35.40.871



EXTENDIBLE DOUBLE NOZZLE
Reference 8.35.40.872



EXTENSION 0.5M
Reference 8.35.40.870



FRONT DOUBLE NOZZLE
Reference 8.34.60.949

SPARE PARTS

Extend the service life of your sprayer easily replacing parts.

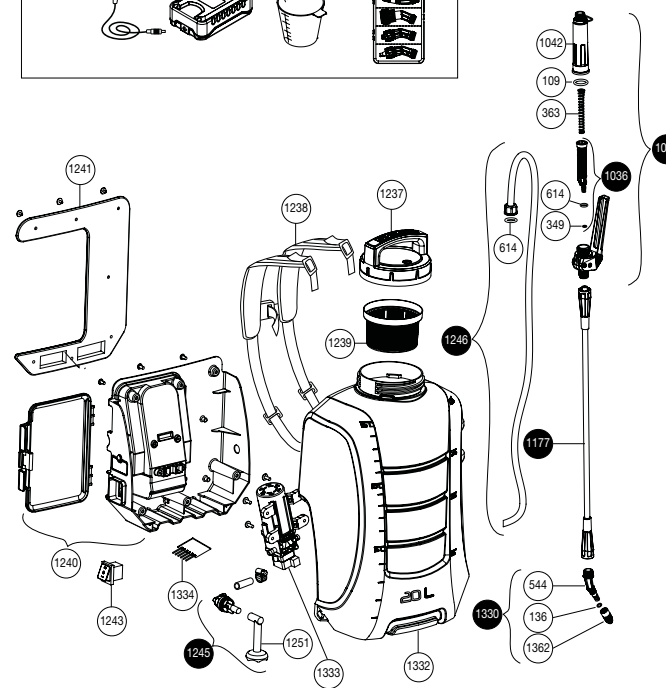
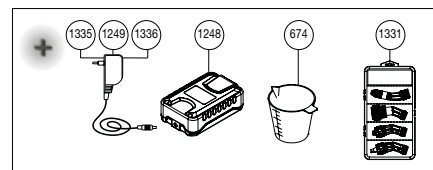

N.	COD.	Q	SPARE PARTS NAME
109	2.23.15.916	1	ROUND GASKET AN-16
136	2.23.15.905	1	ROUND GASKET AN-5
349	2.23.16.903	1	ROUND GASKET AN-3
363	8.39.41.342	1	FILTER SPRING
544	8.28.40.322	1	SPRAYER
614	2.23.16.908	2	ROUND GASKET AN-8
674	8.39.41.350	1	100 ML DOSER
1026	8.49.41.801	1	COMPLETE HANDLE
1036	8.49.41.812	1	FILTER WITH GASKET
1042	8.49.41.367	1	GRIP
1177	8.18.35.627	1	545MM TUBE WITH NUTS
1237	8.30.45.602	1	CAP
1238	8.30.45.607	1	STRAP
1239	8.30.45.302	1	FILTER
1240	8.30.45.603	1	COMPLETE TANK BASE
1241	8.30.45.804	1	BACKREST WITH SCREWS
1243	8.30.45.813	1	3 POSITION SWITCH
1245	8.30.45.605	1	ABSORPTION SYSTEM
1246	8.30.45.806	1	LTC AND LTC-S REPLACEMENT HOSE
1248	8.30.45.816	1	BATTERY (18V LI-ION)
1249	8.30.45.817	1	EU-(BATTERY 18V LI-ION) CHARGER
1251	8.30.45.329	1	ABSORPTION FILTER
1330	8.30.42.807	1	ELBOW WITH NOZZLE
1331	8.34.46.818	1	LTC-S NOZZLES SET
1332	8.30.42.301	1	LTC-S TANK
1333	8.30.42.808	1	LTC-S PUMP
1334	8.30.42.818	1	LTC-S ELECTRONIC BOARD
1335	8.30.45.831	1	USA-(BATTERY 18V LI-ION) CHARGER
1336	8.30.45.832	1	UK-(BATTERY 18V LI-ION) CHARGER
1362	8.30.42.323	1	NOZZLE 2.5 MM