

DOSER

DOSER KNAPSACK

Quick, Easy and Effortless Calibration

Doser is a device specially designed by Goizper for applying liquids in a dosified way

BENEFITS:

- Effective and uniform treatments.
- Product savings.
- Quick and ergonomic..
- Reduces the impact on the environment.

ADVANTAGES:

- Flexibility of a manual tool which allows targeted treatments depending on the crops.
- Adjustable dosing with 3 fixed positions 25 - 50 -75 ml. (cc.).
- Complete emptying of the Pressure Chamber.
- Easy calibration and maintenance.
- Can be converted into a Sprayer.
- Accessories to adapt the equipment to crop requirements.
- Injection Possibility in subsoil.



What types of crops can be used on?

Fruit - Vegetables - Nurseries - Coffee - Banana tree - Oil palm - Tobacco - etc.

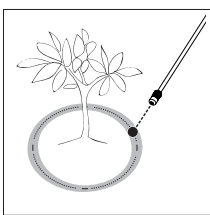

In soils

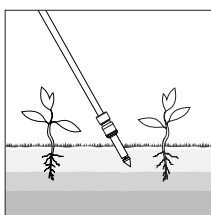

Injection to the subsoil

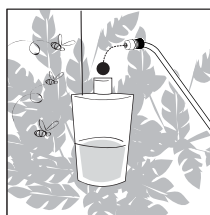

Trap refilling

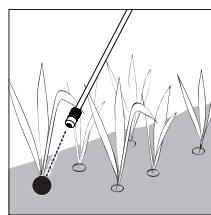

Spot treatments

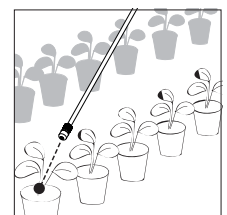
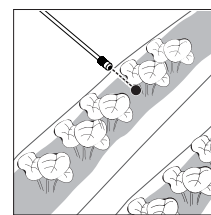

Dosed spraying with the nozzles included



How does it work?. Calibration

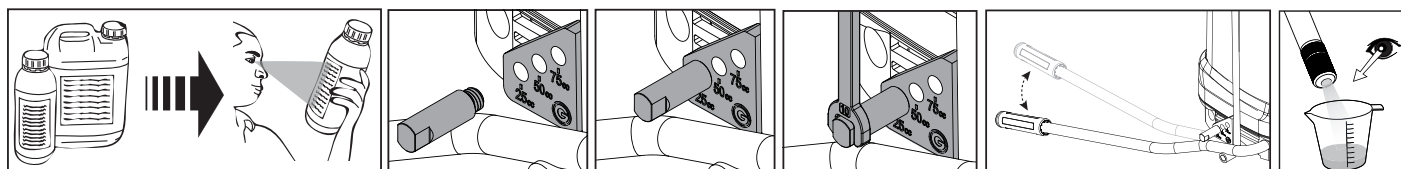

What other options does Doser offer?

Depending on the type of accessories fitted to the Doser, other applications can be obtained:

1. Adjust the length of the 0.65 m lance to 0.20 m

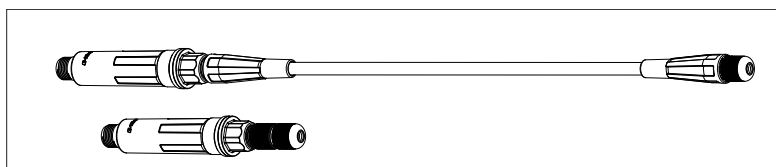

2. Convert into a Sprayer using the conversion kit

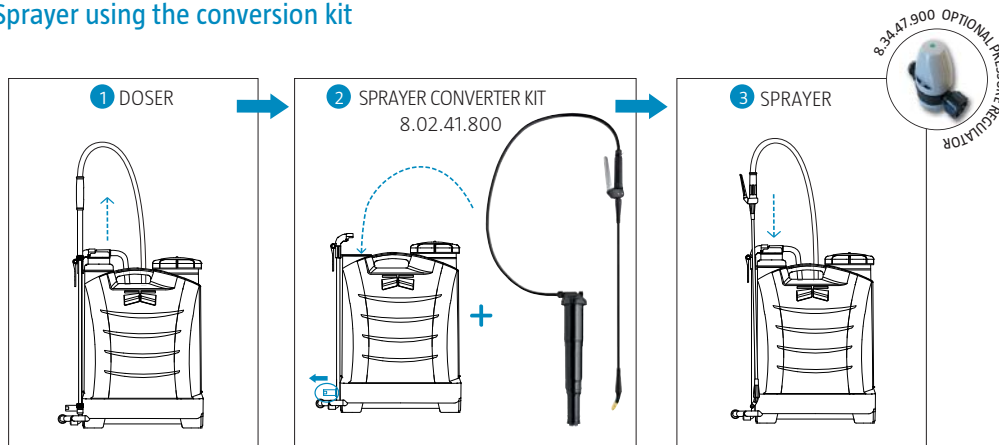

3. Adapt the doser to your crops requirements with our accessories

EXTENSIONS

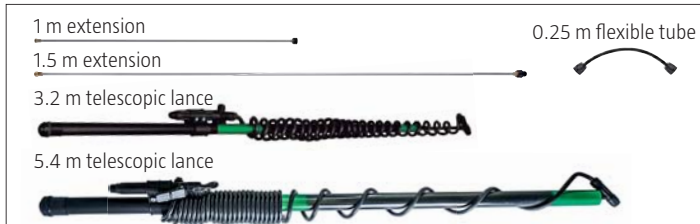

INJECTION TIP

